

Fisher-Price®

H5924
Instructions

Drop & Roar™ Dinosaur



Please keep this instruction sheet for future reference,
as it contains important information.

Requires three "AA" (LR6) **alkaline** batteries (not included).

Adult assembly is required.

Tool required for assembly: Phillips screwdriver (not included).

Parts

⚠ CAUTION

This toy contains small parts in its unassembled state.
Adult assembly is required.

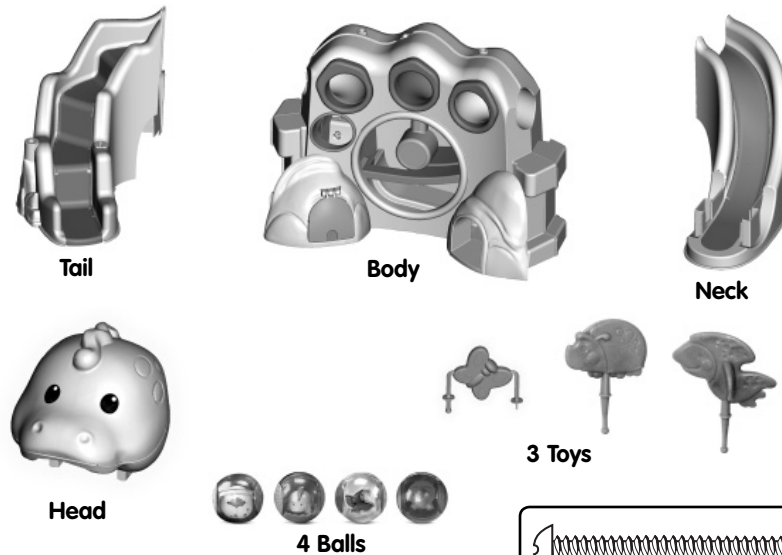

 #6 x 1½" Screw - 2
Shown Actual Size
Note: Tighten or loosen all screws
with a Phillips screwdriver. Do not
over-tighten the screws.

Assembly

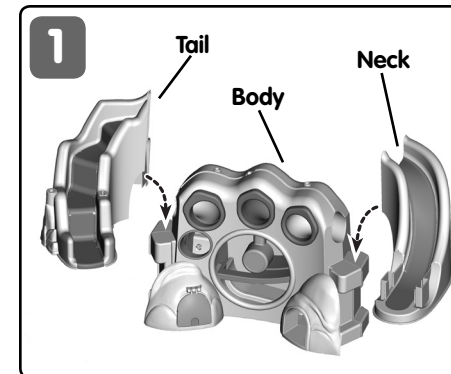

- Slide the tail onto the body, as shown.
- Slide the neck onto the body, as shown.

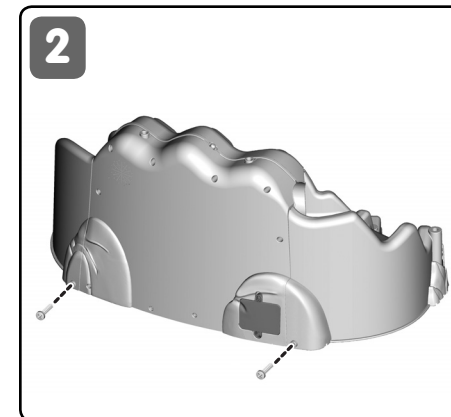

- Turn the assembly around.
- Insert two screws into the assembly and tighten the screws.

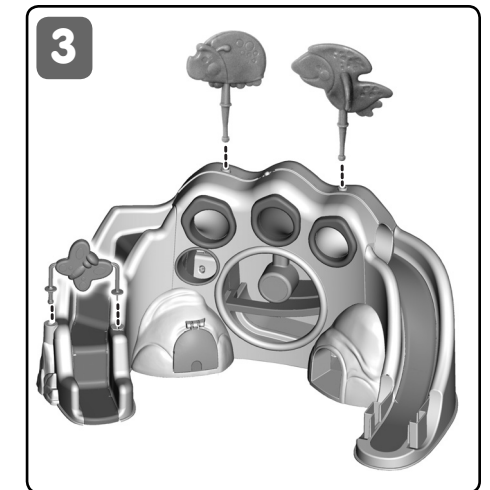

- **"Snap"** the three toys into the assembly.

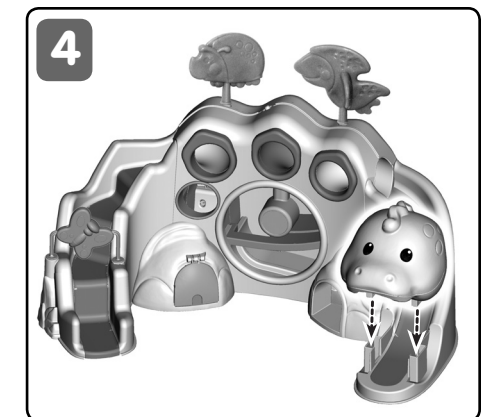

- **"Snap"** the head onto the assembly, as shown.



www.fisher-price.com

Battery Installation

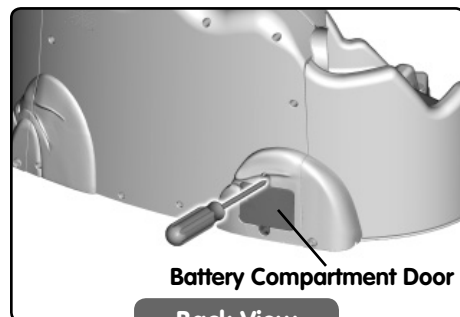

Battery Compartment Door

Back View

- Locate the battery compartment on the back of the toy.
 - Loosen the screws in the battery compartment door with a Phillips screwdriver. Remove the battery compartment door.
 - Insert three "AA" (LR6) **alkaline** batteries, as indicated inside the battery compartment.
- Hint:** We recommend using **alkaline** batteries for longer life.
- Replace the battery compartment door and tighten the screws with a Phillips screwdriver. Do not over-tighten.
 - When lights or sounds from this toy become faint or stop, it's time for an adult to change the batteries!

Battery Safety Information

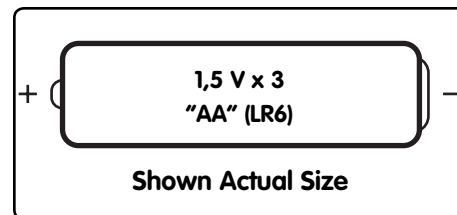

In exceptional circumstances, batteries may leak fluids that can cause a chemical burn injury or ruin your toy. To avoid battery leakage:

- Do not mix old and new batteries or batteries of different types: alkaline, standard (carbon-zinc) or rechargeable (nickel-cadmium).
- Insert batteries as indicated inside the battery compartment.
- Remove batteries during long periods of non-use. Always remove exhausted batteries from the toy. Dispose of batteries safely. Do not dispose of batteries in a fire. The batteries may explode or leak.
- Never short-circuit the battery terminals.
- Use only batteries of the same or equivalent type, as recommended.
- Do not charge non-rechargeable batteries.
- Remove rechargeable batteries from the toy before charging.
- If removable, rechargeable batteries are used, they are only to be charged under adult supervision.

Music, Lights and Rolling Action!

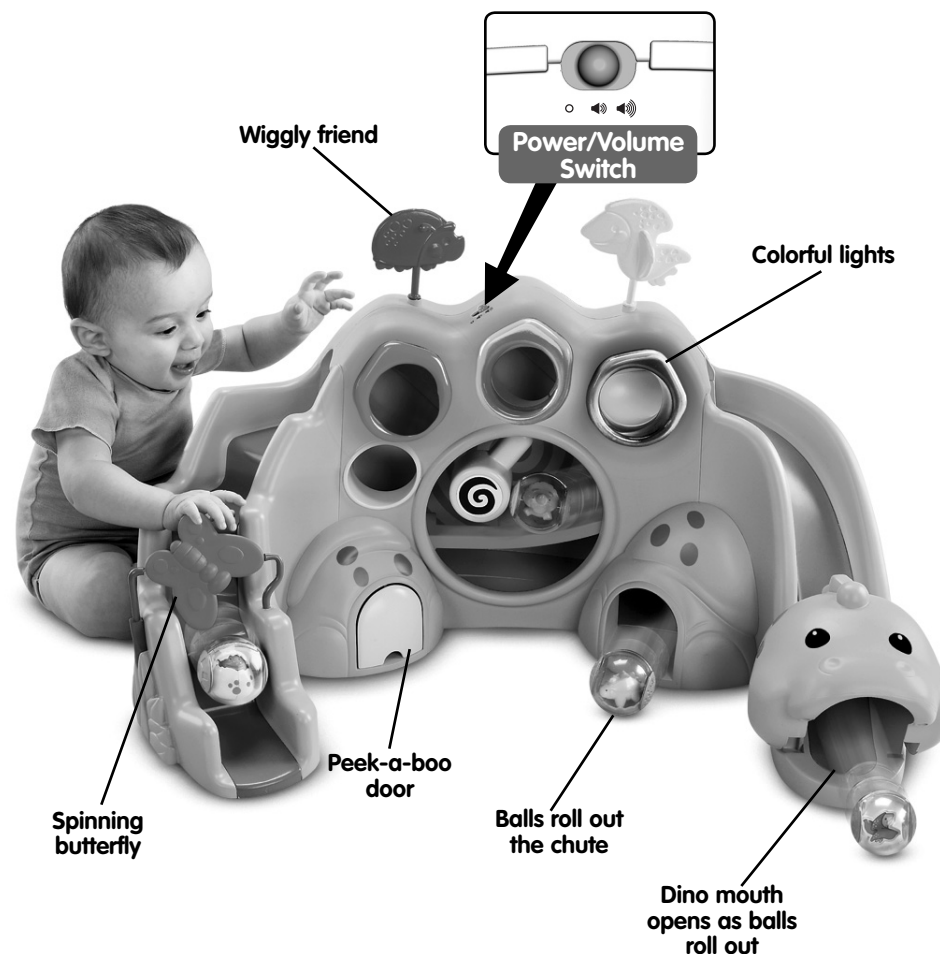

- Locate the power/volume switch on the top of the toy.
- Slide the switch to on with low volume ; on with high volume or off .
- Drop balls into the holes or down the ramps for fun music, lights and dino sounds.

Care

- Wipe this toy with a clean cloth dampened with a mild soap and water solution. Do not immerse this toy.
- This toy has no consumer serviceable parts. Do not take this toy apart.

Consumer Information

Visit us on line at www.service.fisher-price.com.

Call Fisher-Price® Consumer Relations, toll-free at **1-800-432-5437**, 8 AM - 6 PM EST Monday through Friday. Hearing-impaired consumers using TTY/TDD equipment, please call 1-800-382-7470.

Write to us at: Fisher-Price® Consumer Relations, 636 Girard Avenue, East Aurora, New York 14052.

FCC Note (United States Only)

Note: This equipment has been tested and found to comply with the limits for a Class B digital device, pursuant to Part 15 of the FCC Rules. These limits are designed to provide reasonable protection against harmful interference in a residential installation. This equipment generates, uses and can radiate radio frequency energy and, if not installed and used in accordance with the instructions, may cause harmful interference to radio communications. However, there is no guarantee that interference will not occur in a particular installation. If this equipment does cause harmful interference to radio or television reception, which can be determined by turning the equipment off and on, the user is encouraged to try to correct the interference by one or more of the following measures:

- Reorient or relocate the receiving antenna.
- Increase the separation between the equipment and receiver.
- Consult the dealer or an experienced radio/TV technician for help.

Note: Changes or modifications not expressly approved by the manufacturer responsible for compliance could void the user's authority to operate the equipment.

For countries outside the United States:

CANADA: Questions? **1-800-432-5437**. Mattel Canada Inc., 6155 Freemont Blvd., Mississauga, Ontario L5R 3W2; www.service.mattel.com.

GREAT BRITAIN: Mattel UK Ltd, Vanwall Business Park, Maidenhead SL6 4UB. Helpline: 01628 500303. www.service.mattel.com/uk.

AUSTRALIA: Mattel Australia Pty. Ltd., 658 Church Street, Locked Bag #870, Richmond, Victoria 3121 Australia. Consumer Advisory Service 1300 135 312.

NEW ZEALAND: 16-18 William Pickering Drive, Albany 1331, Auckland.

ASIA: Mattel East Asia Ltd, Room 1106, South Tower, World Finance Centre, Harbour City, Tsimshatsui, HK, China.